

# B702, B703

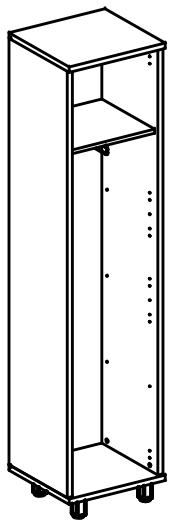

B702

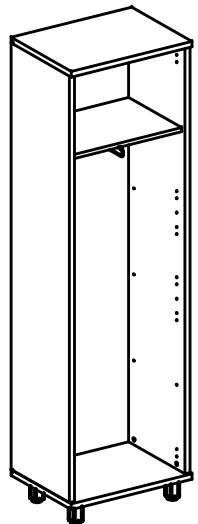

B703

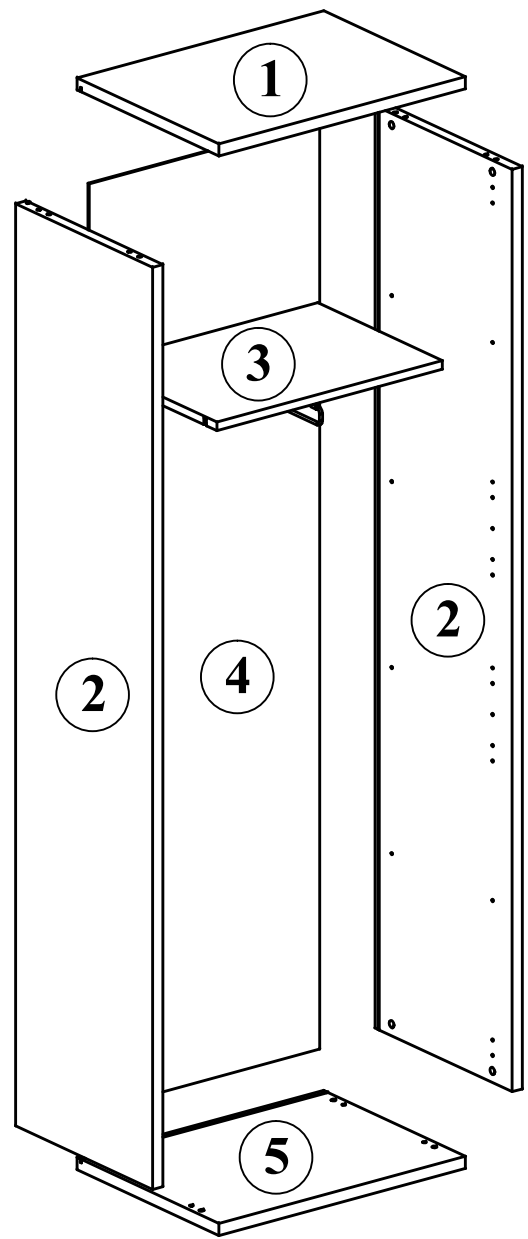

1		x8
2		x8
3		x8
4		x8
5		x4
6		x4
7		x8
8		x2
9		x28
10		x1
11		x4
12		x4
13		x12



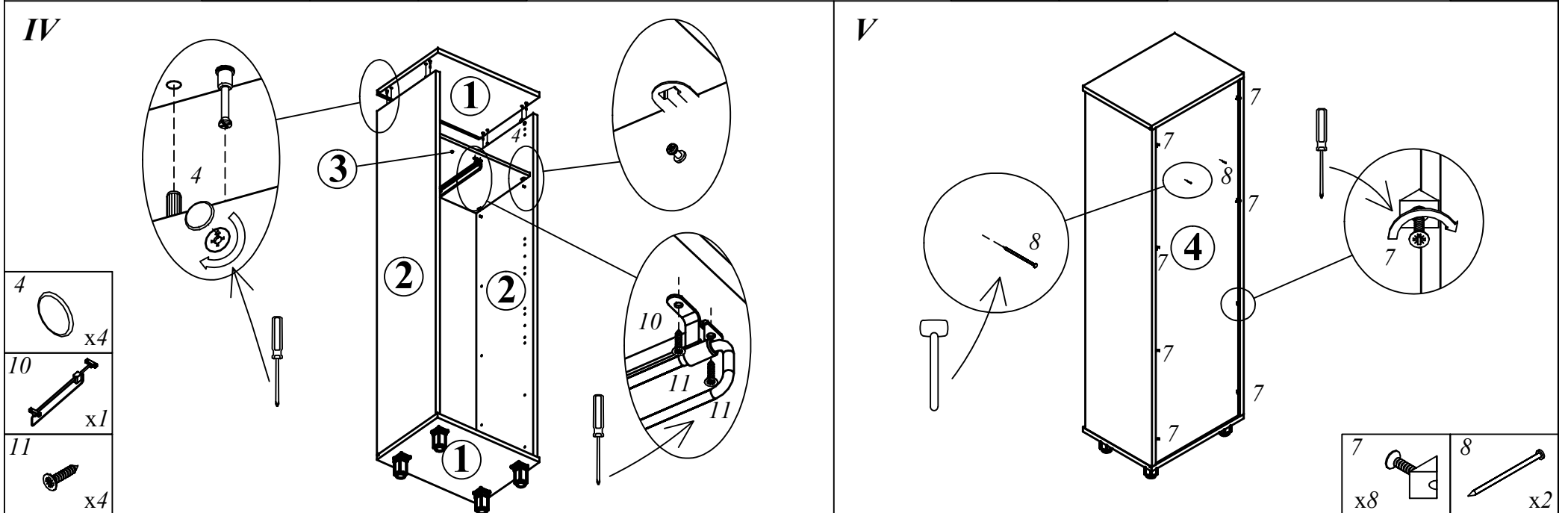
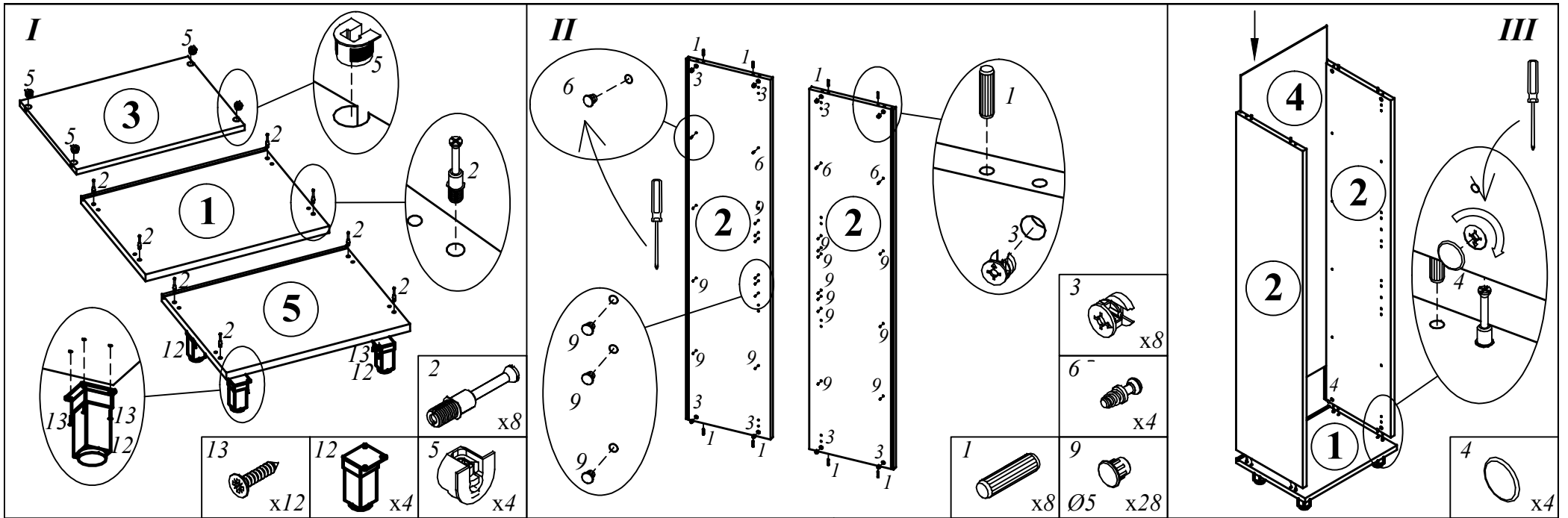

**B 702, B703**

# B510(L/R); B520(L/R); B530; B531

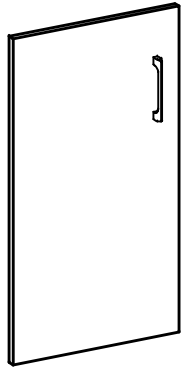
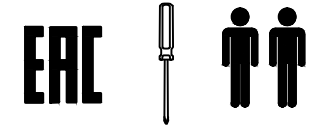

**B510(L)**  
765x422x18

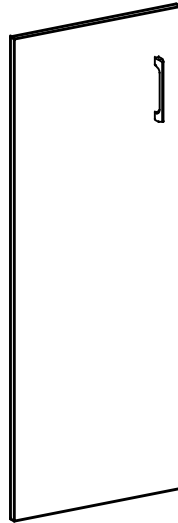

**B520(L)**  
1131x422x18

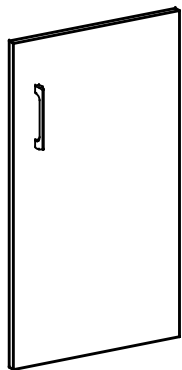

**B510(R)**  
765x422x18

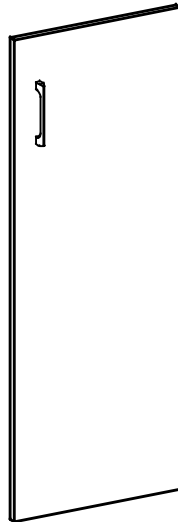



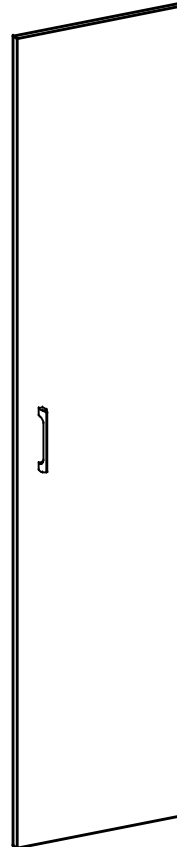

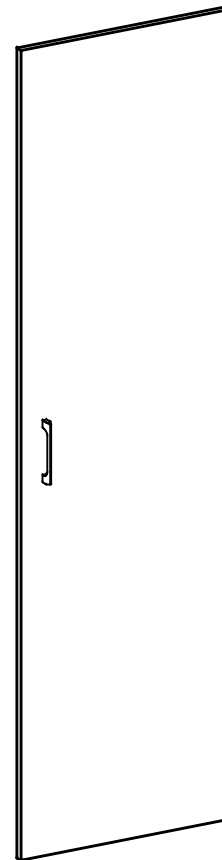

**B520(R)**  
1131x422x18

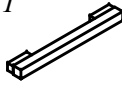

**B530**  
1900x422x18

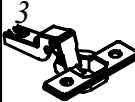

**B531**  
1900x545x18

	B510(L/R) B520(L/R)	B530 B531
1 	x1	x1
2  M4x22	x2	x2
3 	x2	x4
4 	x2	x4
5 	x4	x8
6 	x4	x8
7 	x1	x1

